



R E P O R T

**IBV**  
INSTITUTO DE  
BIOMECÁNICA

**OFFICE CHAIR. ERGONOMIC  
EVALUATION**

On request of: **FORMA 5 S.L.U.**

Code: 130142 - PV12/0186

Date: JULY 2013

## SIGNATURES AND AGREEMENT CONDITIONS

---

Technical Responsible: **Mr. José Francisco Serrano Ortiz**  
Technological Services Staff, IBV

Signature:



Date: 23/07/2013

Manager of the service: **Mr. José David Garrido Jaén**  
Technological Services Manager, IBV

Signature:

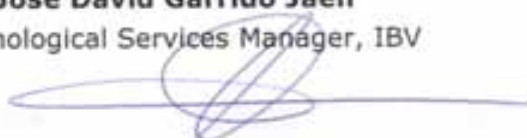

Date: 23/07/2013

### AGREEMENT CONDITIONS

1. The Instituto de Biomecánica de Valencia (IBV) is only responsible for the results stated in this report, which refer exclusively to the materials or samples indicated in it and which will remain in our hands. Unless otherwise stated, the samples have been freely chosen and sent by the petitioner.
2. The IBV is not responsible in any case for the misinterpretation or misuse that can be done of this report, the reproduction of which, in its whole or part, with publicity purposes and without authorization from the IBV, is forbidden.
3. The results of this report are considered the petitioner's property and without his previous consent, the IBV will not communicate them to a third party.
4. The samples subject of this report will remain in the IBV during a period of six months beginning from the date of issue of this report. After this period, we will proceed to their destruction. Therefore, any claim must take place within the aforementioned period.

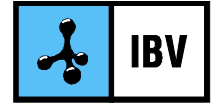

## **C o n t e n t s**

SIGNATURES AND AGREEMENT CONDITIONS

1. INTRODUCTION AND OBJECTIVES

2. MATERIAL AND METHODS

3. RESULTS

ANNEX

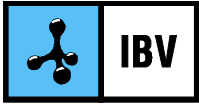

130142 - PV12/0186

## 1. INTRODUCTION AND OBJECTIVES

---

The objective of the test is the ergonomic evaluation of the office chair, according to own procedures of IBV.

The evaluation carried out covers the following aspects:

- 1. Evaluation of the dimensional and functional suitability.** Correspondence between the dimensions of the product and the use it is intended for.
- 2. Temporary evolution of the general comfort and discomfort in different parts of the body.** To check if the comfort and discomfort levels are stable or if they undergo changes during a typical period of use.
- 3. Relationship between discomfort in parts of the body and general comfort.** To establish if there is a relationship between the discomfort that increases with time and general comfort.
- 4. Subjective perception of the characteristics of the chair.** To consider the opinion of the population regarding the design characteristics.
- 5. Pressure distribution.** To detect possible problems with the chair regarding comfort and functionality related to inadequate distribution of pressure on the seat.
- 6. Analysis of the use of the backrest.** To check that the design of the backrest allows correct support of the back in the lumbar and dorsal regions.

The tests were requested by the company: FORMA 5, S.L.U., located at: C/ Acueducto, 12-14. 41703- Pol. Ind. Ctra. La Isla, Parcela. 35A. 41703 Dos hermanas. Sevilla.



## 2. MATERIAL AND METHODS

The coding and description of the sample is shown in the following table:

SAMPLE	DESCRIPTION ACCORDING TO THE PETITIONER
MU13-0256	<p><b>2K8</b> model Office Chair: high-backed swivel chair, ergonomic seat with and mesh backrest.                      Regulations and components of the test unit:</p> <ul style="list-style-type: none"> <li>- Lumbar Support</li> <li>- Synchro Motion</li> <li>- Trasla Mechanism</li> <li>- 3D adjustable armrests</li> </ul> 

The study carried out consists of three types of tests:

**Dimensional suitability tests. Geometrical** measurements of concordance between the dimensions of the product and the use it is intended for.

**Comfort tests. Subjective** tests in which the overall level of comfort, discomfort in specific parts of the body and general opinion regarding certain characteristics of the product are quantified through the use of questionnaires filled in by potential users.

**Biomechanical tests. Objective** tests in which certain corporal parameters related to comfort levels of the subjects are measured such as the distribution of pressure on the seat and the level of use of the backrest.

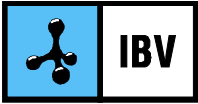

130142 - PV12/0186

## 2.1 DIMENSIONAL SUITABILITY TESTS.

The measurements were taken using a backrest and seat load simulator built by IBV in accordance with the Swedish standard SS 839140. This device permits us to obtain measurements under conditions similar to those of use, bearing in mind the distribution of the loads a standard user applies to the seat and the backrest.

The dimensions measured were as follows:

### Dimensions of the seat

The basic dimensional functions of the seat are as follows (Figure 1):

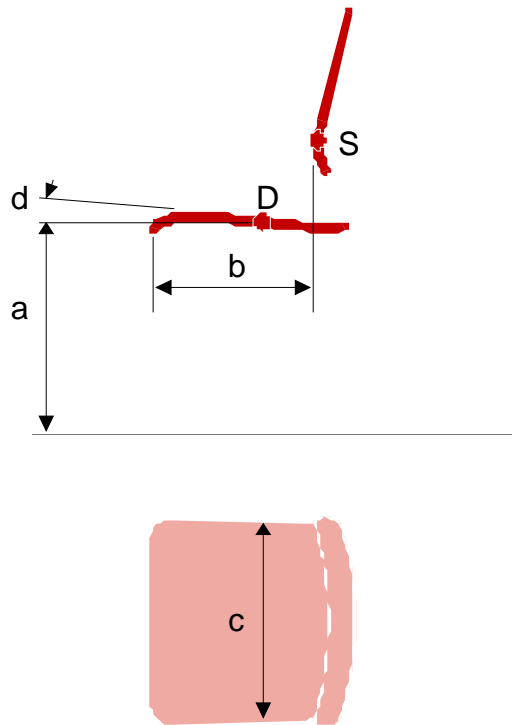

Figure 1. Functional dimensions of the seat.

- (a) *Seat height.* The seat height refers to the height from the floor to the maximum support point of the seat, which corresponds to the ischiatic bones.
- (b) *Useful depth of the seat.* The distance between the front edge of the seat and the projection over it of the nearest point of the backrest (point S).
- (c) *Seat width.* The width of the seat measured at the maximum support point of the seat.
- (d) *Seat tilt.* The angle described between the plane of the seat to the horizontal. Forward tilts are known as positive tilts (front edge down) and backward tilts are negative tilts (front edge up).

## Backrest dimensions

The functional dimensions of the backrest are as follows (Figure 2):

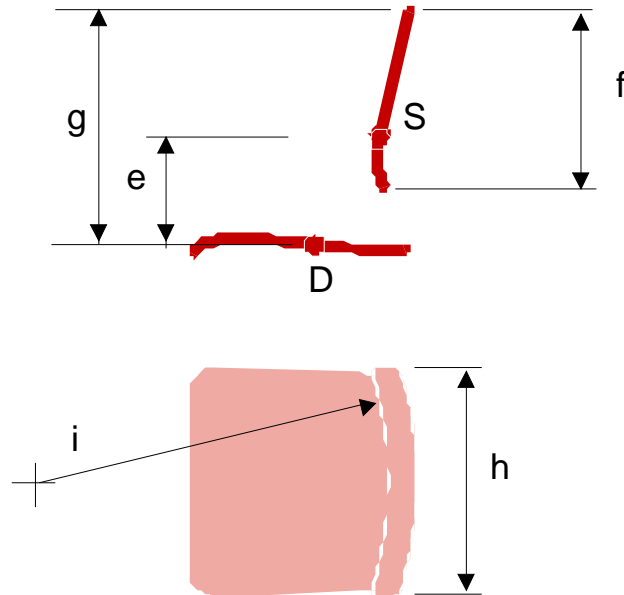
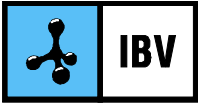

Figure 2. Functional dimensions of the backrest.

- (e) *Height of the lumbar region over the seat.* The vertical distance between point S of the backrest and point D of the seat.
- (f) *Height of the backrest.* The vertical distance between the upper and lower edges of the backrest.
- (g) *Height of the upper edge of the backrest.* The vertical distance between the upper edge of the backrest and point D of the seat.
- (h) *Width of backrest.* This is the maximum width the backrest has in the range of: the height of point S (lumbar region support) and the height of S + 300.
- (i) *Curvature radius of the horizontal profile of the backrest.* This measurement is taken horizontally at point S of the backrest.
- (j) *Field of regulation of the tilt of the backrest.* This is the tilt range of the backrest from the vertical plane.



130142 - PV12/0186

### Dimensions of the armrests

The functional dimensions to be considered when dealing with armrests are as follows (Figure 3):

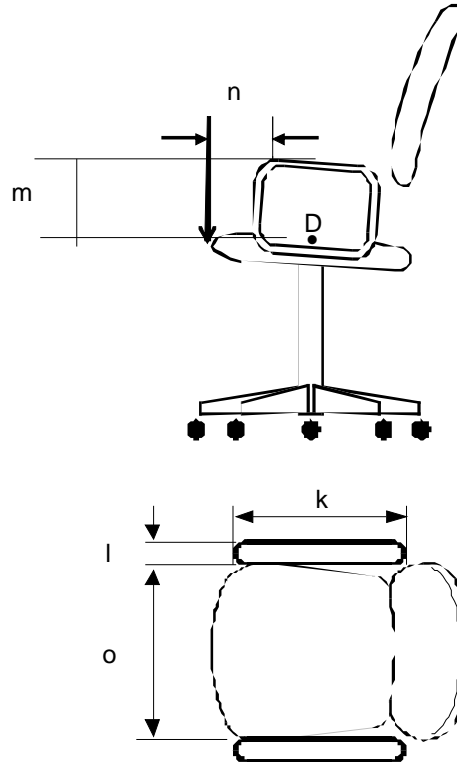

Figure 3. Functional Dimensions armrests.

- (k) *Useful length of the armrests.* Horizontal distance between the useful extremes of the armrests.
- (l) *Useful width of the armrests.* Width of the armrests at the same level as point D.
- (m) *Height of armrests.* The height of the armrests is measured from the seat, taking the maximum support point (point D) as a reference.
- (n) *Distance from front edge of armrest to front edge of seat.* This position is determined by the horizontal distance between the front edge of the armrests and the front edge of the seat.
- (o) *Distance between armrests.* The horizontal distance between the inner edges of the armrests, measured on the transversal plane at the height of point D.

### Dimensions of the chassis

The dimensions to be considered in the definition of the chassis are as follows (Figure 4):



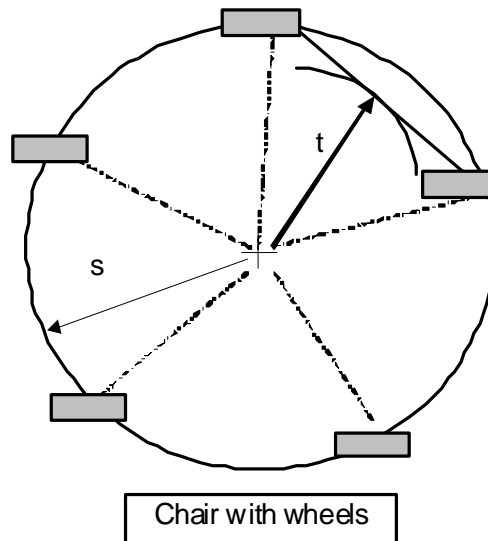

Figure 4. Dimensions of the chassis.

- (s) *Maximum projection of the chassis.* The maximum distance between the outermost point of the chassis and the rotation axis of the chair.
- (t) *Stability scale.* The minimum distance of support from the joining line between two adjacent points and the rotation axis of the chair.

The support points are the fixed or mobile points of the chair that are in constant contact with the floor. When wheels are used they are always placed in the most unfavourable positions.

## 2.2. COMFORT TESTS

During the comfort tests subjective responses have been analysed from the users based on the procedure as described by Shackel and by Corlett and Bishop. This procedure is based on three types of tests.

- General comfort test.
- Tests for discomfort on parts of the body.
- Subjective opinions about the characteristics of the product.

These tests were carried out in the Ergonomics laboratory at the IBV, simulating real conditions of use of the product. In order to do so, two office posts were set up. The sample of users who took part in the tests comprised 12 subjects (6 men and 6 women).

Each of the tests lasted for 1.5 hours, having observed the following test protocol.

- 1) The subject sat on the chair to be evaluated in order to carry out the task in question without receiving any indications as to the posture that should be adopted. In this way spontaneous behaviour could be evaluated. The subjects were explained about the use of the adjustments of the chair or it was adjusted by the technician.
- 2) At the start of the test the subject filled in the relevant questionnaires for the general comfort test and the test for discomfort on parts of the body. In the

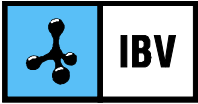

130142 - PV12/0186

former, the subject had to state his/her level of comfort at that time, on a scale of 9 points (1 = completely relaxed, 9 = very uncomfortable). In the latter, they had to mark off the points of the body where discomfort or pain appeared on a scale of 5 points (5 = pronounced discomfort or pain; 1 = slight discomfort; no score = absence of discomfort in that part of the body).

- 3) The aforementioned questionnaires were filled in 30, 60 and 90 minutes later. Each questionnaire was taken away once it was filled in to avoid the previous answers having an influence on the following ones.
- 4) Once the test was finished, the subject answered a test on subjective opinions about the characteristics of the product, where they were asked about specific aspects of it.

From the responses obtained through the **general comfort test**, the evolution in time of the discomfort level was analysed, establishing whether or not there was a significant increase in the level and evaluating the overall response concerning the ranges of normality of tests with other models of chairs. Through this process, the general level of comfort of the tested product could be established.

The information obtained from the **discomfort on parts of the body tests** is useful for:

- a) Determining the evolution in time of the discomfort level in those parts of the body mentioned by the users. In this way it could be checked if the level of discomfort on different parts of the body increased continually or if it became stable and the importance of the maximum level of discomfort reached could be evaluated.
- b) Once those parts of the body where discomfort appeared through the use of the product had been selected, we then moved on to analyse which were associated with the increase in the overall discomfort level. This analysis allowed for the selection of parts that were affected by discomfort enough to produce a negative overall sensation through the use of the product.

The subjective opinion test regarding the characteristics of the product allows for the detection of, in the first stage, those characteristics of the piece of furniture that are most unsuitable in the opinion of the users, and secondly it permits a comparison of the evaluation of each point with normal ranges from analyses of other chair models.

### 2.3. BIOMECHANICAL TESTS

The results obtained from these tests permit the assessment of the objective causes that give rise to the significant discomfort mentioned in the previous section.

The tests carried out are:

- Analysis of the pressure distribution over the seat. This variable is usually associated with the possibility of discomfort in the buttocks and thighs.
- Analysis of the use of the backrest. This variable is usually associated with the appearance of possible discomfort in the back (lumbar or dorsal regions).



The tests consist of the following:

- a) **Analysis of the distribution of pressure points on the seat.** The distribution of pressure points on the seat is measured by sitting a subject on the seat and placing a system of pressure sensors between the subject and the seat "Xsensor". The aforementioned test were carried out on the seat, comparing the maximum pressure values with the serious discomfort limit values.

From the recording obtained, the following parameters were measured for each subject who sat in the chair:

- Maximum pressure (pressure on the support area of the isquiatic bones).
- Average pressure.

- b) **Analysis of the use of the backrest.** One of the factors that greatly reduces the appearance of discomfort in different parts of the body while maintaining a sitting position, is the presence of a backrest that provides suitable support for the lumbar region and that prevents the trunk of the body from adopting bent or very straight postures. In order to measure the degree and way of using the backrest, a device consisting in a group of flexible electrodes was used. The electrodes are extremely fine and are fitted to the backrest and on different parts of the subject's back. From the different combinations of contact between the electrodes on the subject's back and the backrest, it can be determined if the subject is using the backrest or not and how it is being used, i.e., if the subject receives support to the lumbar region or if not, if slouching occurs. During each session of use of the backrest, the subject sat for 1.5 hours on the chair being tested, while at the same time carrying out comfort tests.

The equipment used for the carrying out of the tests is shown in the following table:

EQUIPMENT
<ul style="list-style-type: none"> <li>• Thermo-hygrometer</li> <li>• Chair measuring equipment</li> <li>• Reference dummy</li> <li>• Tape measure</li> <li>• Digital inclinometer</li> <li>• Calibre</li> <li>• XSENSOR Pressure recording system</li> <li>• Contact recording system</li> <li>• Weigh scales</li> </ul>

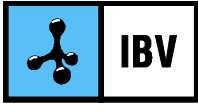

130142 - PV12/0186

### 3. RESULTS

#### 3.1 DIMENSIONAL SUITABILITY

The following table shows the results of the measurements taken:

DIMENSION	MU13-0102		CRITERIA	VALUATION
	Backrest forward	Backrest back		
<b>SEAT</b>				
Height (mm)	436-541	461-576	≤420 - ≥510	Not suitable
Height regulation (mm)	105		≥100	Suitable
Useful depth (mm)	446-496	481-531	≤400 - ≥420	Not suitable
Depth regulation (mm)	50		≥50	Suitable
Width (mm)	460		≥400	Suitable
Tilt (°)	-0,2	-9,8	≤(-2) - ≥(-7)	Suitable
Regulation d (°)	9,6		≥6	Suitable
<b>BACKREST</b>				
Height of top edge (mm)	632		≥360	Suitable
Width (mm)	460		≥360	Suitable
Curvature radius of the horizontal profile (mm.)	672		≥400	Suitable
Height of lumbar support (mm)	122-172		≤170 - ≥220	Not suitable
Height regulation (mm)	50		≥50	Suitable
Tilt angle (°)	8,1 – 27,2		-	-
Tilt regulation (°)	19,1		≥15	Suitable
<b>ARMRESTS</b>				
Useful length (mm)	250		≥200	Suitable
Useful width (mm)	84,4		≥40	Suitable
Height (mm)	196 - 296		≥200 - ≤250	Suitable
Height regulation (mm)	100		-	-
Distance to the front edge of seat (mm)	104 – 142		≥100	Suitable
Distance between armrests (mm)	491		≥460 - ≤510	Suitable
<b>CHASSIS</b>				
Maximum projection (mm)	384		≤415	Suitable
Stability level (mm)	426		≥195	Suitable

VALUATION OF THE DIMENSIONAL SUITABILITY. IMPROVABLE



### 3.2 COMFORT TESTS

The comfort tests were carried out using the procedure explained in the previous chapter with a sample of 12 subjects, 6 men and 6 women, with the following corporal characteristics (average ± typical deviation):

SAMPLE OF TEST SUBJECTS:

	Size	Weight
<b>Men</b>	173.2 ± 6,0 cm	81,3 ± 11,7 kg
<b>Women</b>	161,3 ± 5,0 cm	59,2 ± 6,5 kg

#### General comfort test

Figure 1 shows the evolution in time of the level of general discomfort over a period of 1.5 hours. The graph shows the average values and the interval of 95% LSD. The discomfort scores are those taken from the aforementioned comfort test (1 = completely relaxed, 2 = very comfortable, 3 = fairly comfortable, 4 = comfortable, 5 = normal, 6 = slightly uncomfortable, 7 = uncomfortable, 8 = fairly uncomfortable, 9 = very uncomfortable).

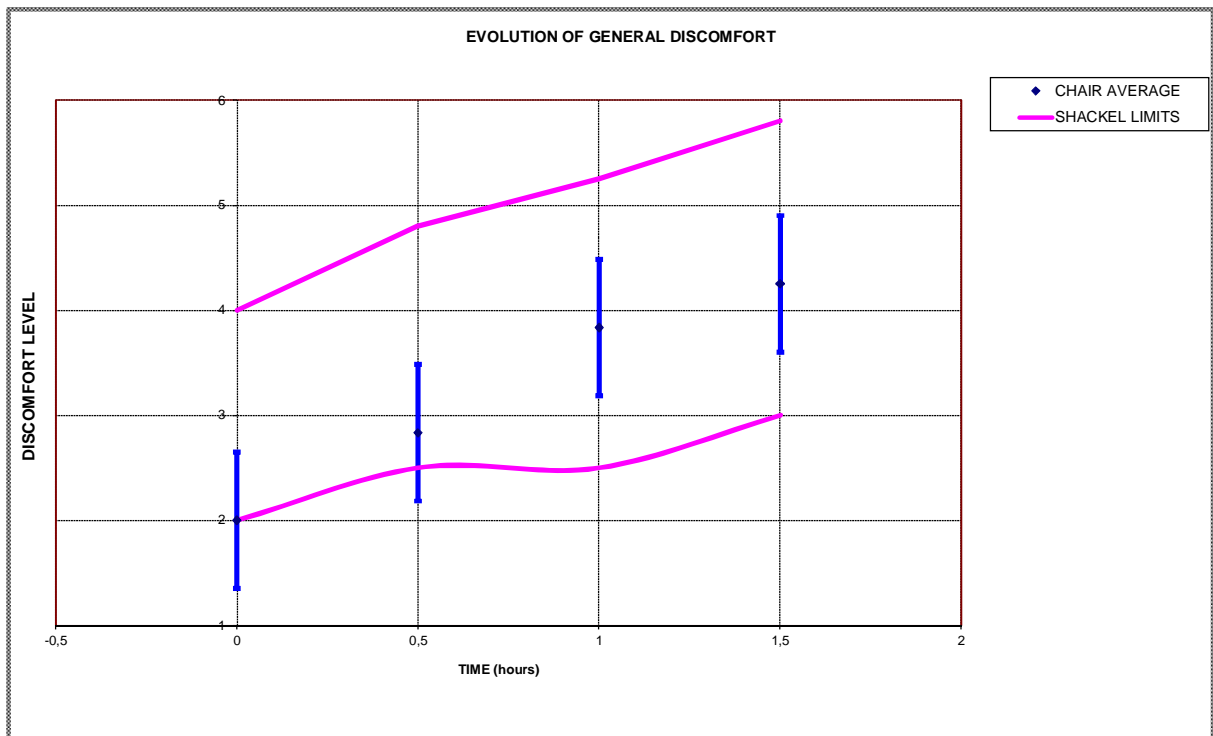
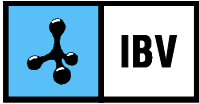

Figure 5. Evolution in time of the discomfort level.

As can be seen, the levels of general comfort in the chair vary, both at the beginning of the test and throughout the whole time scale, between the situations of **very comfortable** to **comfortable**. The evolution of the discomfort throughout the test shows



130142 - PV12/0186

how the behaviour of the chair evolves with time between the zones of very comfortable to comfortable.

On the other hand, Figure 6 shows the evolution of the general comfort level of the tested chair compared to the range established by IBV for office chairs.

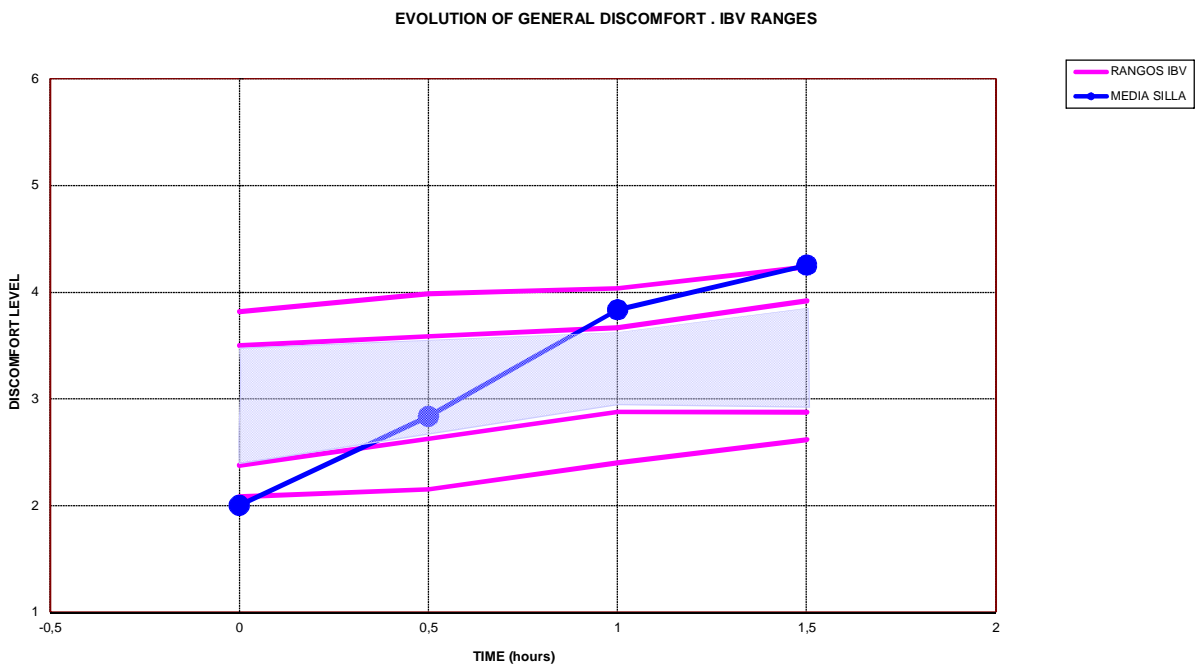

Figure 6. Evolution of general discomfort. IBV Ranges

This graph shows that in the last half hour of the test there is a significant increase in discomfort being close out the set range.

The discomfort seen increased statistically significant over time.

VALUATION OF THE GENERAL COMFORT TEST: ACCEPTABLE

### Test for discomfort on parts of the body

One of the objectives of this test is to select those parts of the body where discomfort arises that is significant enough to affect the overall comfort of users.

To do this, first we analyzed the temporal evolution of the level of discomfort.

Figures 7, 8 and 9 show the average values of the significant discomfort increases observed (in dorsal area, lumbar area and buttocks) with indication of the confidence interval 95% LSD.

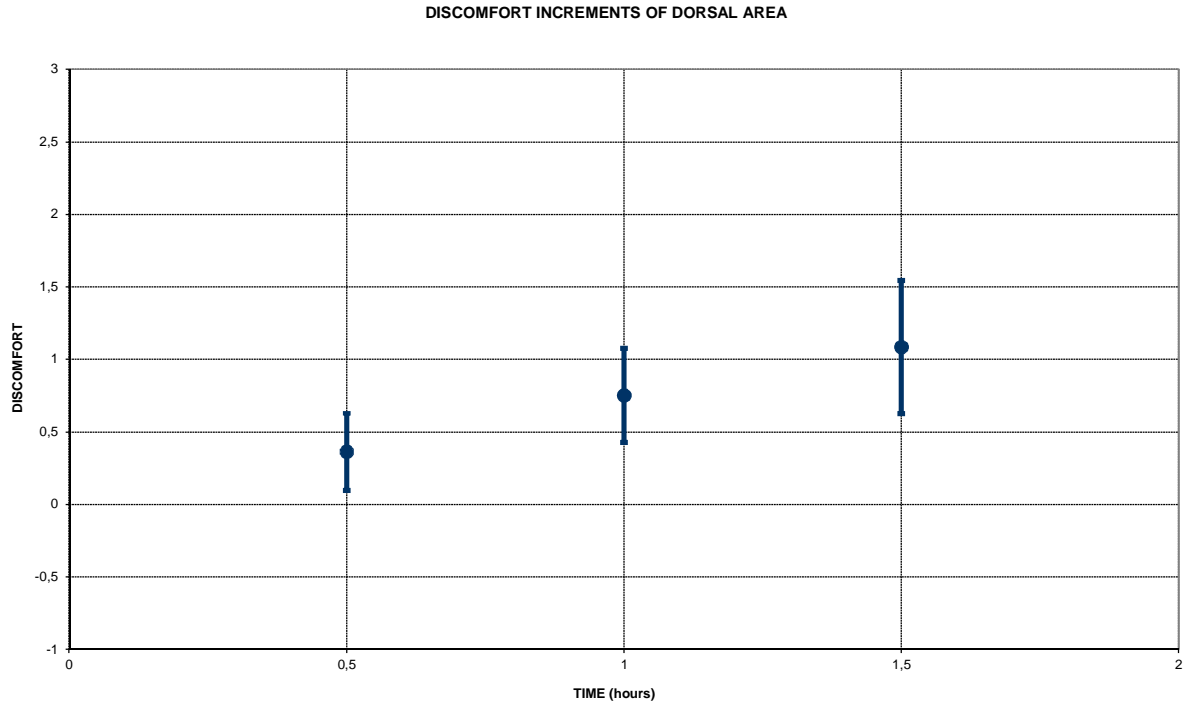
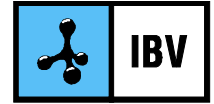

Figure 7. Evolution of discomfort in dorsal area

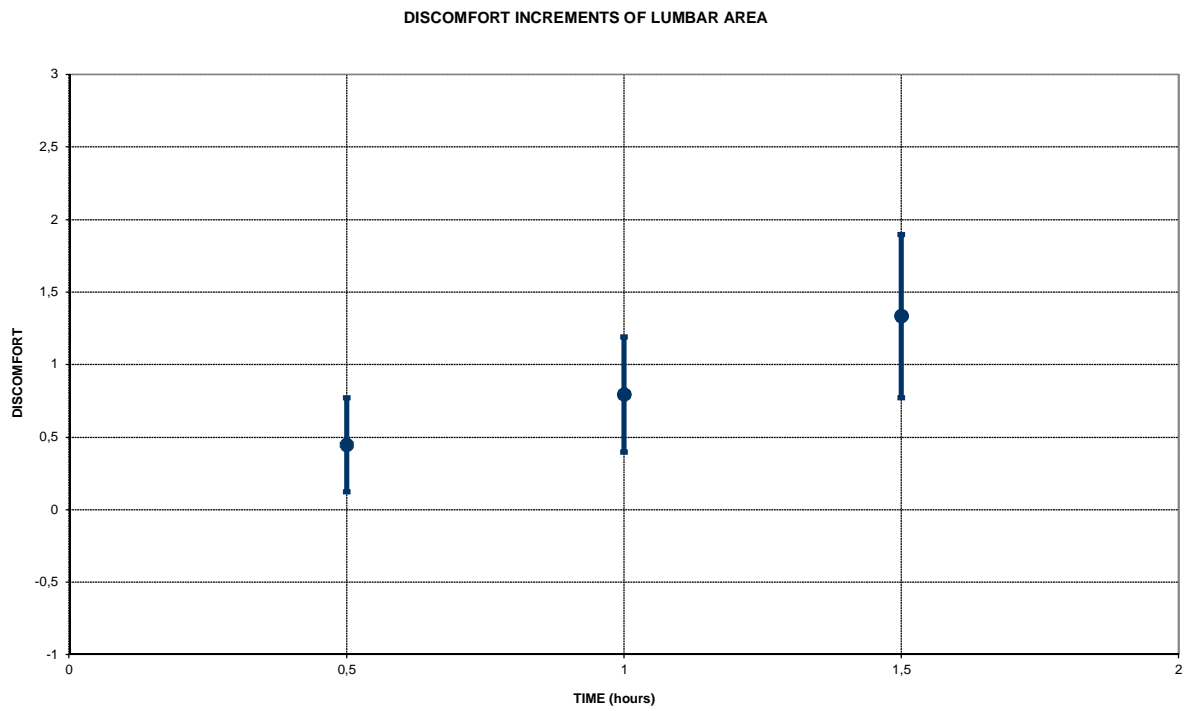
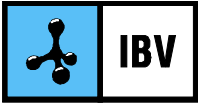

Figure 8. Evolution of discomfort in lumbar area



130142 - PV12/0186

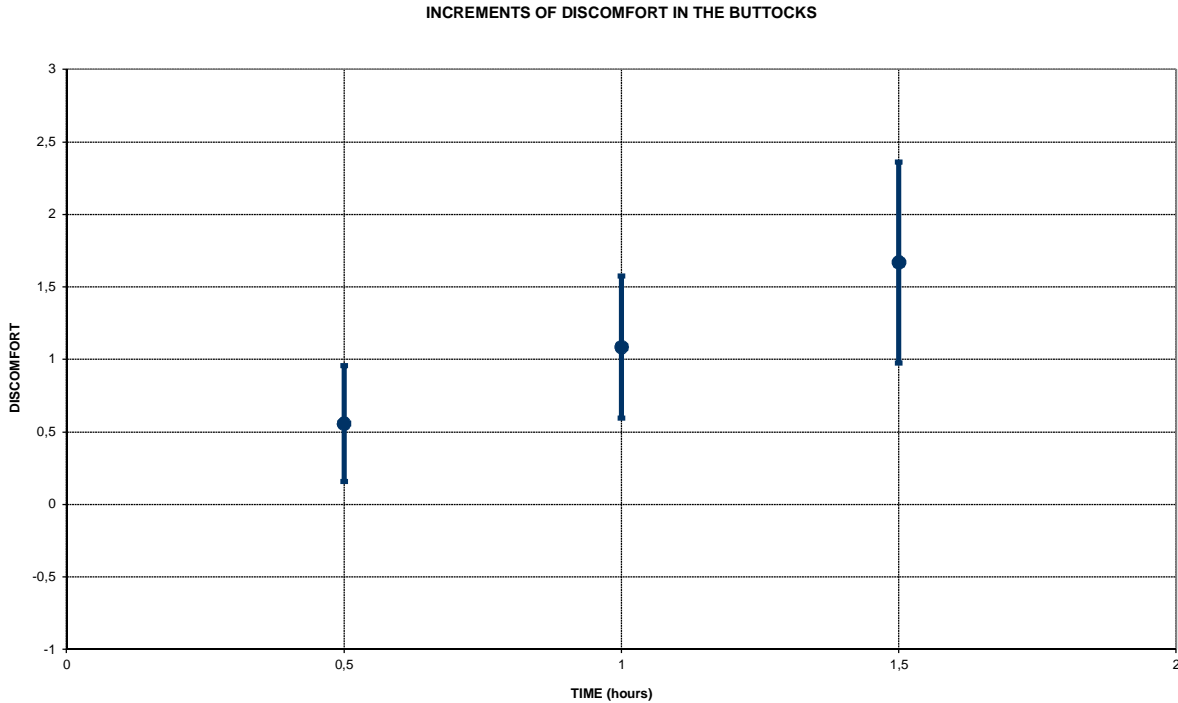

Figure 9. Evolution of discomfort in the buttocks

The following table (Table 1) answers the question of which of the discomfort increased over time are related to the increased level of discomfort.

Correlations	ICONF	IDOR	ILUM	IBUT
ICONF	-	0,0002	0,0002	0,0001
IDOR	0,0002	-	0,0166	0,2277
ILUM	0,0002	0,0166	-	0,0005
IBUTT	0,0001	0,2277	0,0005	-

Table 1. Correlation between discomfort and general comfort

There is statistically significant correlation between increasing discomfort over time (dorsal, lumbar and buttocks) and general comfort with a significance level of  $\alpha < 0.05$ . Therefore, the increased discomfort in the dorsal, lumbar and buttocks over time is significantly associated with increased discomfort.

VALUATION OF THE TEST FOR DISCOMFORT ON DIFFERENT PARTS OF THE BODY - ACCEPTABLE





**Test of subjective opinions about the characteristics of the product**

Table 2 includes the results of the assessment of the characteristics which asked respondents to rate. Figures in Annex 1 are plotted using these valuations inverted triangles on a graphic scale corresponding to the frequency of occurrence of negative judgments by excess or defect (Figure 10).

The separation of a triangle of the central strip indicated by a vertical black stripe indicates the proportion of complaints in that regard. The existence of a single triangle indicates that only negative evaluations were conducted in this regard. If the triangle is on the central black stripe indicates that there have been no complaints in any way. A triangle on either end indicates that all subjects complained that way.

Colored bands indicate normal area in one and in another case they show the comparison with other chairs analysed by IBV.

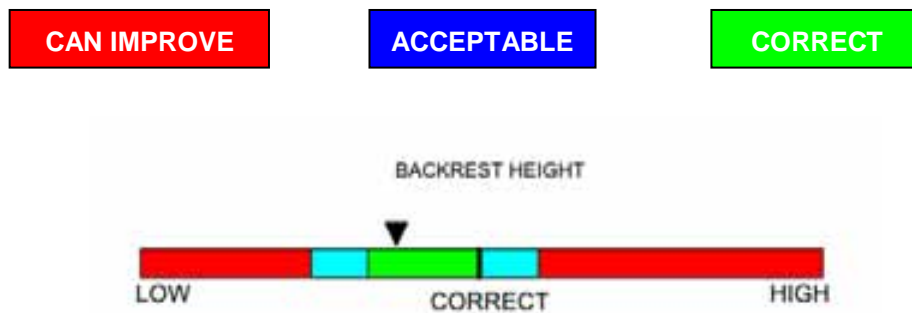
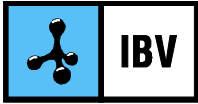

Figure 10. Example graphical representation of subjective judgments



130142 - PV12/0186

TABLE 2. CHARACTERISTICS OF THE CHAIR EVALUATED BY THE SUBJECTS

DIMENSIONAL CHARACTERISTICS OF THE CHAIR	EVALUATION
Seat height.	Correct
Seat depth.	Correct
Seat material.	Correct
Seat shape.	Correct
Does the front edge dig in?	No
<b>Separation between armrests</b>	
Separation between armrests	Excessive
Height of the armrests	Correct
Width of the armrests	Correct
Length of the armrests	Correct
Shape of the armrests	Correct
<b>Height of the upper edge of the backrest</b>	
Height of the upper edge of the backrest	Correct
Height of the lumbar support	Correct
Height of the backrest	Correct
Vertical profile of the backrest	Correct
Horizontal profile of the backrest	Correct
Does any part dig in your back?	No
Backrest material	Correct
<b>Overall evaluation of the chair</b>	<b>Between Comfortable and Normal</b>

SEAT HEIGHT REGULATION	EVALUATION
Ease of height regulation	Easy
Access to regulation control	Normal
<b>SEAT DEPTH REGULATION</b>	
Ease of depth regulation	Normal
Access to regulation control	Normal
<b>LOCKING OF BACKREST</b>	
Users finds required level of support	Yes
Ease of locking backrest	Normal
Access to locking control	Normal
Unlocking movement of the backrest	Correct
<b>LUMBAR SUPORT REGULATION</b>	
Ease of lumbar support regulation	Easy
Access to regulation control	Normal
Hardness of the regulator	Correct
<b>ARMREST HEIGHT REGULATION</b>	
Ease of regulating height	Easy
Access to regulation control	Comfortable

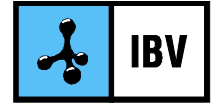

BIOMECHANICAL TESTS

Analysis of pressure distribution

The maximum pressure is that related to the appearance of discomfort problems, as maximum pressures over 40 kPa give rise to discomfort in most users. Table 3 shows the results from the measurements taken regarding the distribution of pressure on the seat.

CHAIR	Pmax (kPa)	Pmed (kPa)	Super. (cm <sup>2</sup> )
<b>MU13-0256</b>	14,93	4,83	1230,74

TABLE 3. Maximum and average pressure in chair

In this table, it can be seen that the chair provides a suitable weight distribution of the users with **maximum pressures that do not exceed the limit of 40 kPa**.

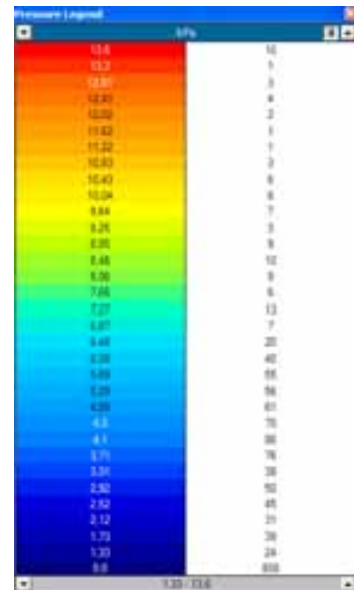
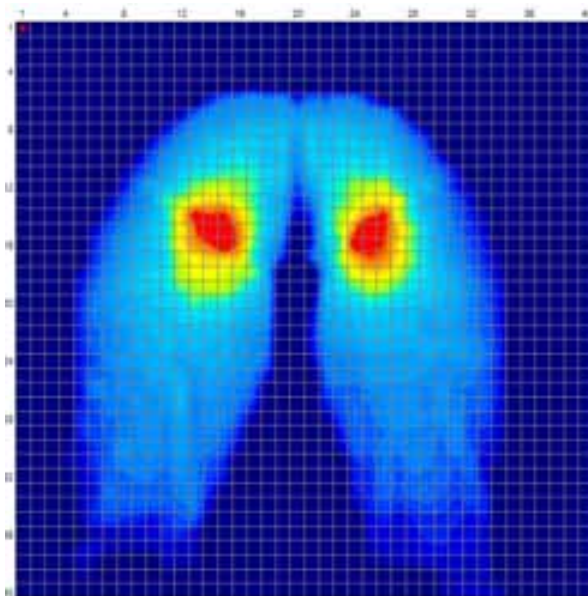

EVALUATION OF THE PRESSURE DISTRIBUTION – GOOD

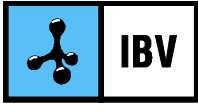

130142 - PV12/0186

**Use of the backrest**

In these tests the percentage of time the backrest was used was recorded, and at the same time what kind of use it was put to. To do so, a device designed by IBV was used that allows recording contact between the back of the subject (lumbar and dorsal regions) and the backrest of the product. In Table 4 the average values of the percentage of times of contact are shown for the two regions of the back and the percentage of time without any contact at all.

TABLE 4. Percentage of time the back regions use the backrest

MU13-0256	%
NO SUPPORT	0,65
ONLY LUMBAR REGION	5,58
ONLY DORSAL REGION	6,80
BOTH DORSAL AND LUMBAR REGIONS.	86,97

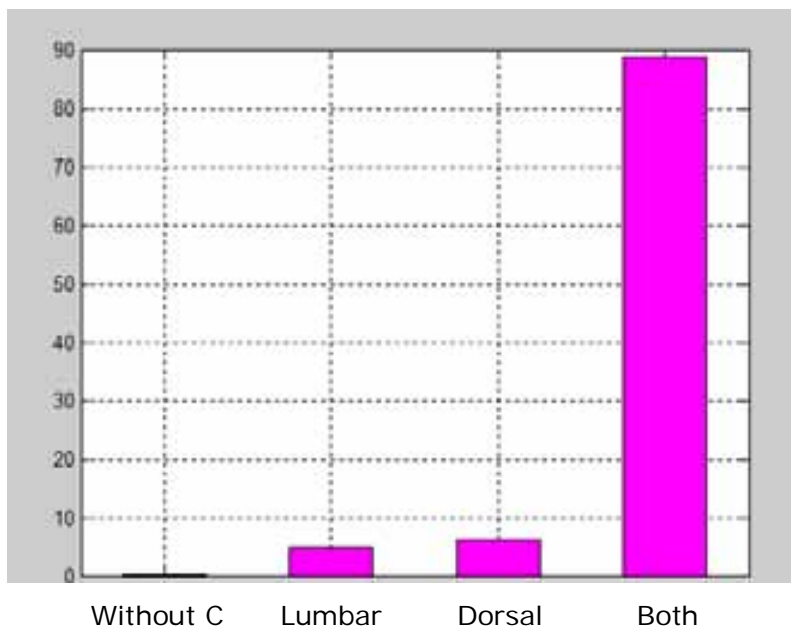

Figure 11. Backrest usage analysis

As a conclusion it is worth mentioning that the subjects in the tests remained in a position that allowed for the correct support of the back (only lumbar and both) for 92,55% of the time and the postures without contact and straight (only dorsal) accounting for 7,45% of the time and therefore the result is good.

VALUATION OF THE ANALYSIS OF BACKREST USE - GOOD



**ANNEX**

---

EVALUATION OF THE CHARACTERISTICS OF THE CHAIR

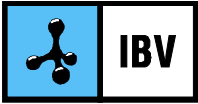

130142 - PV12/0186

### CHARACTERISTICS OF THE CHAIR EVALUATED BY THE SUBJECTS

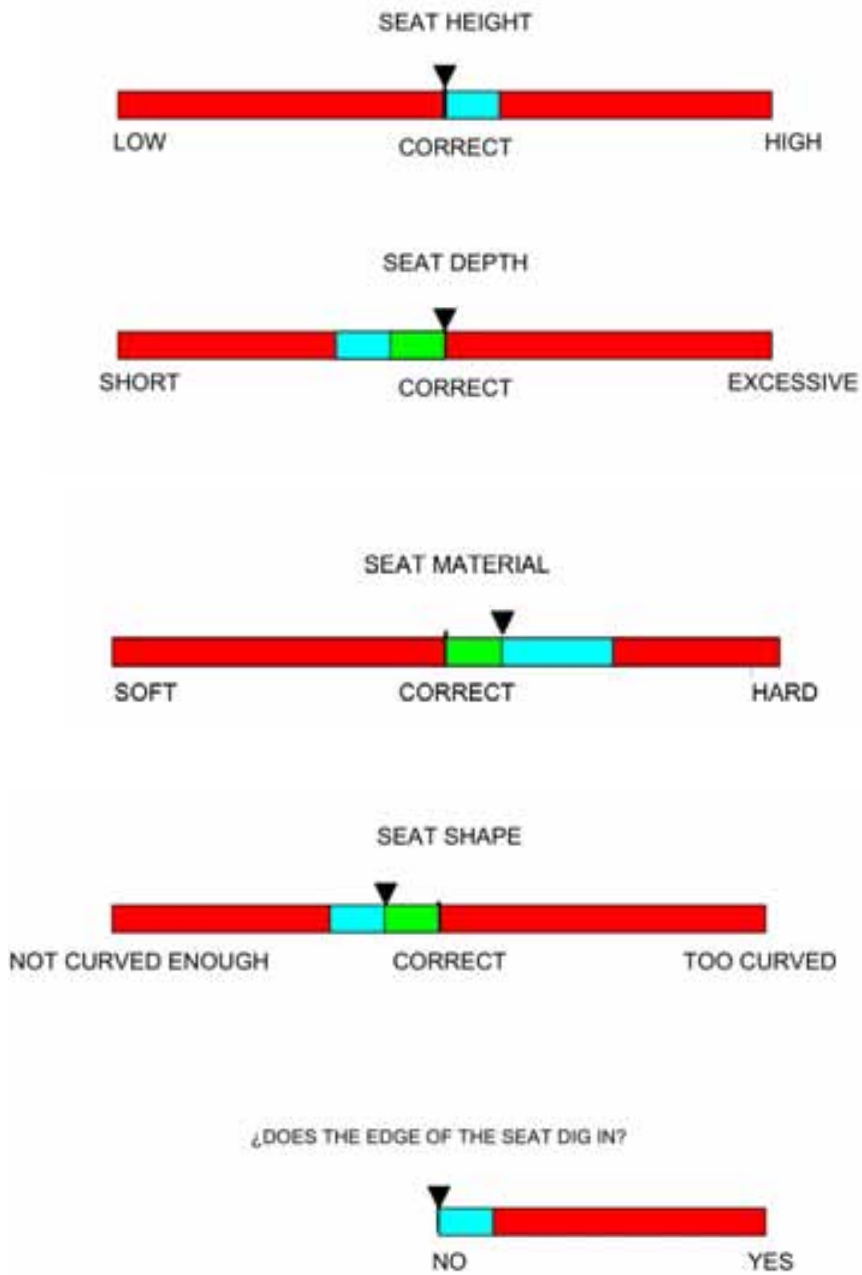

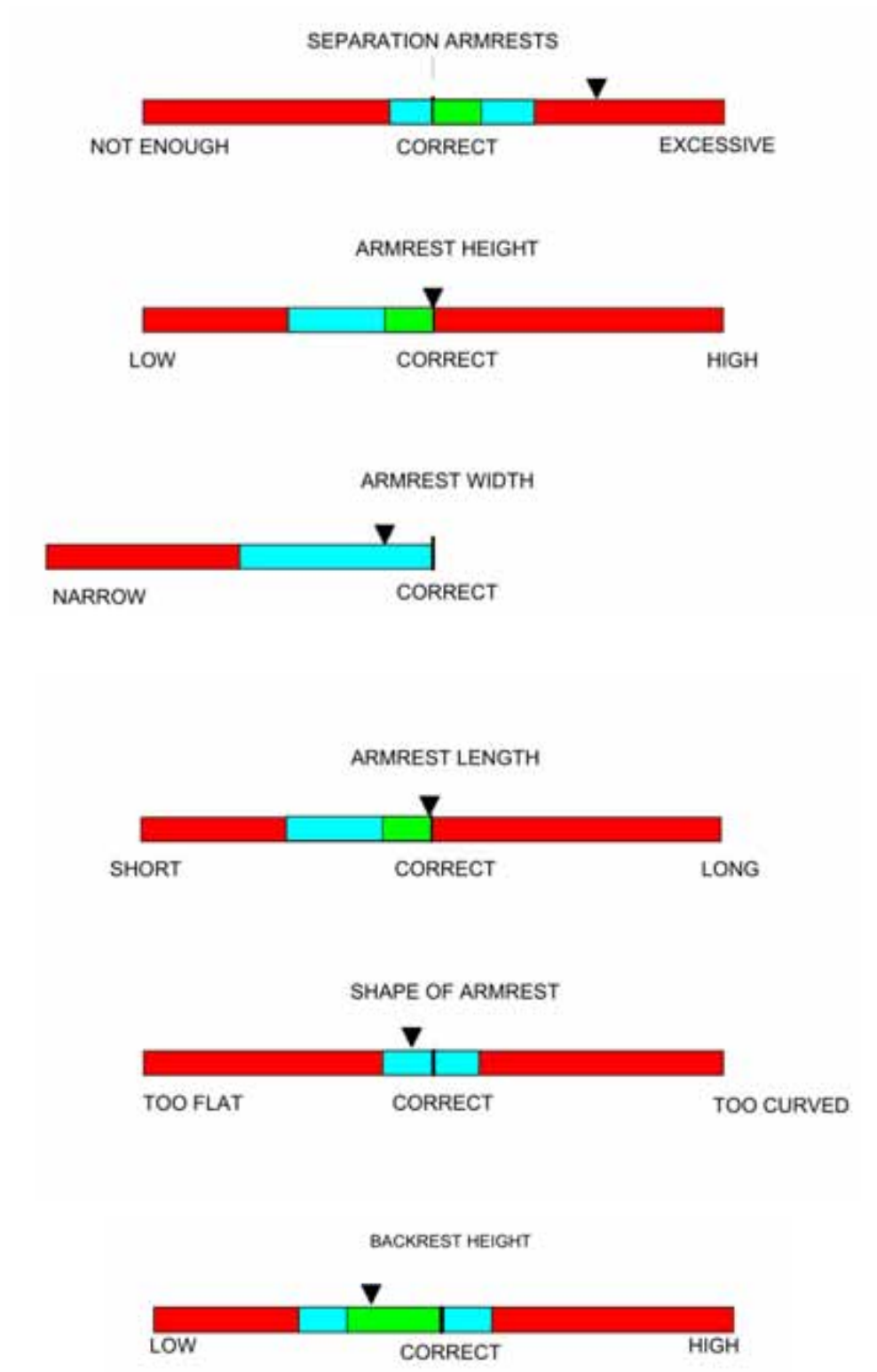



130142 - PV12/0186

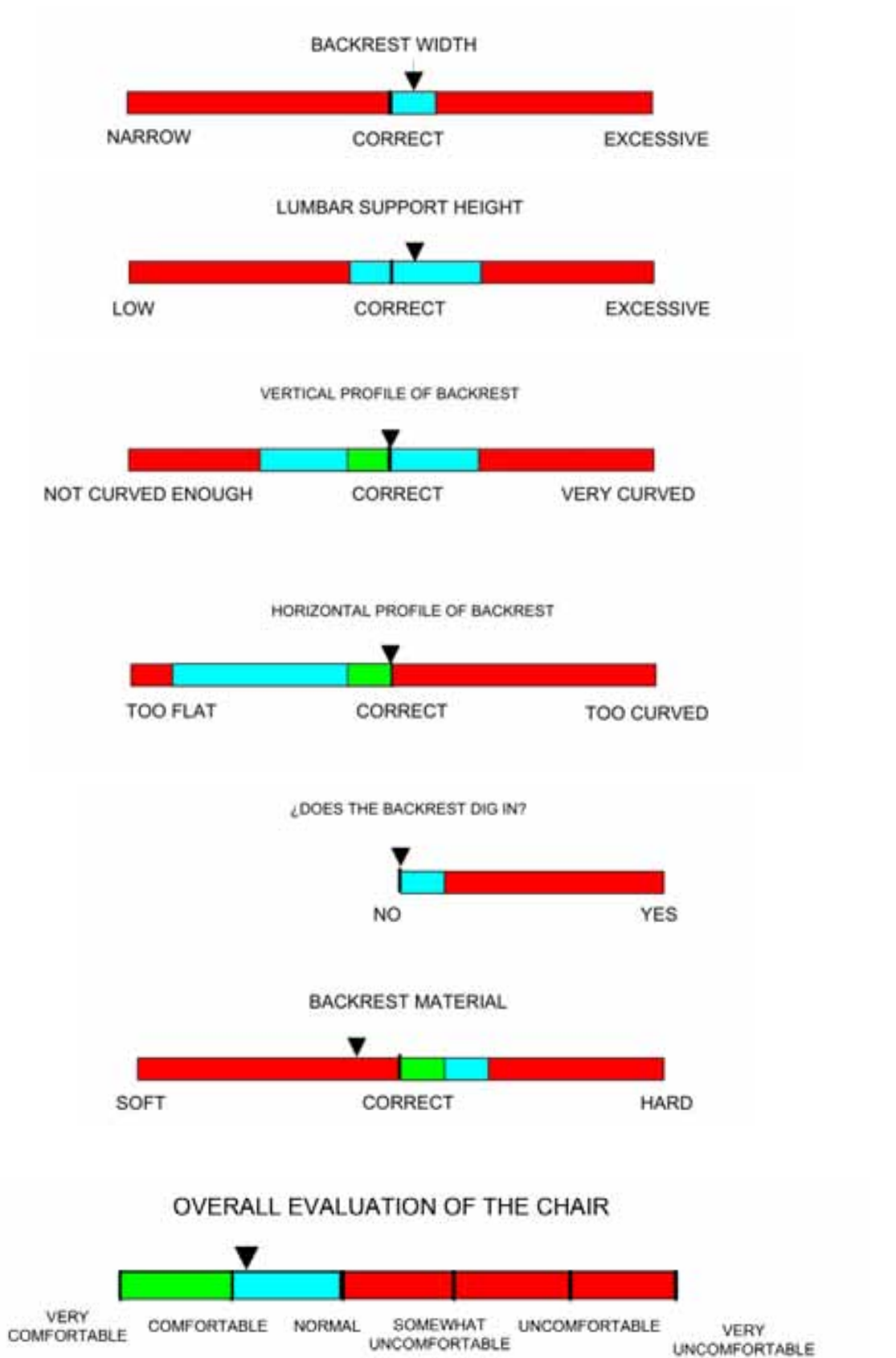





### MECHANISMS

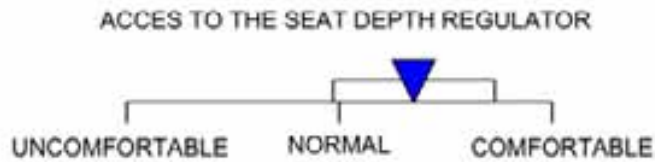
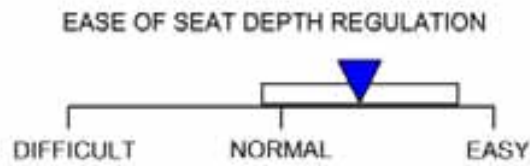
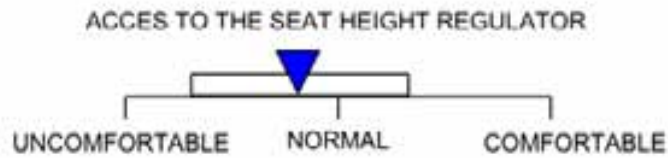
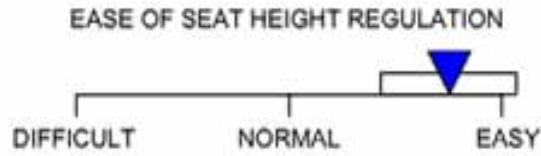

¿DOES THE BACKREST SUPPORT THE USER IN ANY POSITION?

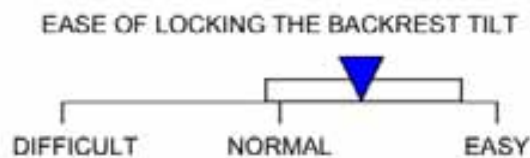
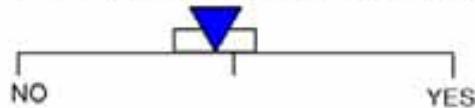



130142 - PV12/0186

ACCESS TO THE BACKREST TILT LOCK CONTROL

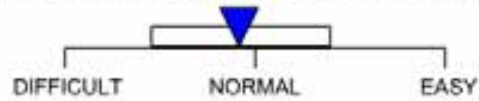

UNLOCK MOVEMENT OF BACKREST POSITION

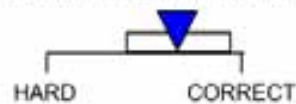

EASE LUMBAR SUPPORT REGULATION

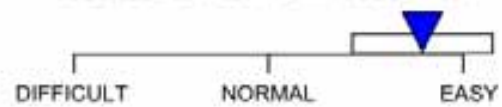

ACCESS TO THE LUMBAR SUPPORT REGULATOR

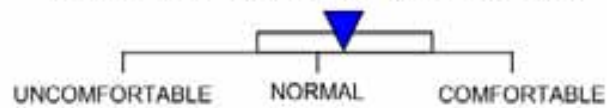

HARDNESS OF THE LUMBAR SUPPORT REGULATOR

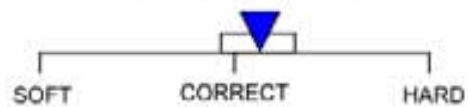

EASE OF REGULATING THE HEIGHT OF THE ARMRESTS

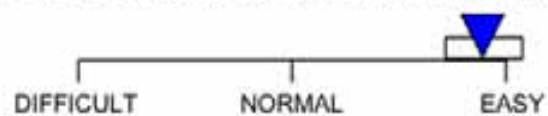

ACCESS TO THE ARMRESTS HEIGHT REGULATOR

